

Notes:

1. Maximum Electric Current: 125A
2. Maximum Electric Rating: Up to 2000V
3. Terminal Material: Copper
4. Wire Range: 4 AWG

Standard (Metric)

L1: 0.71 (18mm)
D: 0.28 (7mm)
D1: 0.26 (6.6mm)
D2: 0.35 (8.8mm)

Tolerances

(Unless Otherwise Specified)

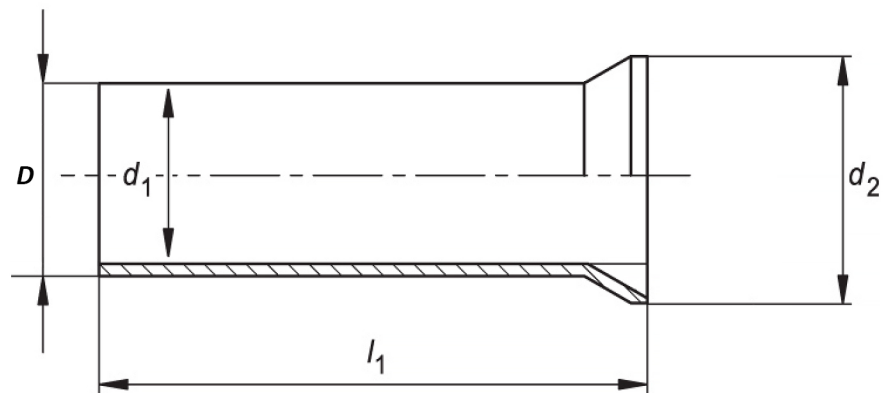

CATEGORY

Non Insulated
Wire Ferrule

SCALE

4/1

PART #

SF212018

SHEET

1-1

MATERIAL

Tin-Plated Copper

PAGE



FerrulesDirect

