

Notes:

1. Maximum Electric Current: 360A
2. Maximum Electric Rating: Up to 2000V
3. Terminal Material: Copper
4. Wire Range: True 4/0 AWG

Standard (Metric)

L1: 1.34 (34mm)
D: 0.63 (16mm)
D1: 0.59 (15mm)
D2: 0.69 (17.5mm)

Tolerances

(Unless Otherwise Specified)

CATEGORY	Non Insulated Wire Ferrule	SCALE	4/1
PART #	SF1120034	SHEET	1-1
MATERIAL	Tin-Plated Copper	PAGE	

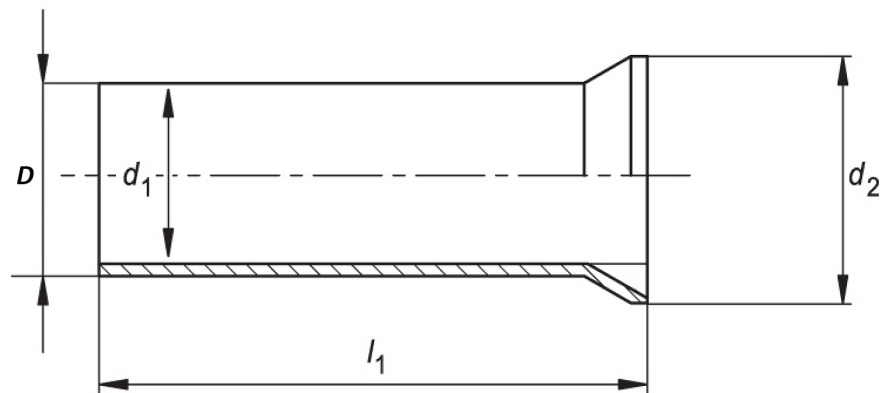

FerrulesDirect

