

Notes:

1. Maximum Electric Current: 360A
2. Maximum Electric Rating: Up to 2000V
3. Terminal Material: Copper
4. Wire Range: True 4/0 AWG

Standard (Metric)

L1: 0.98 (25mm)
D: 0.63 (16mm)
D1: 0.59 (15mm)
D2: 0.69 (17.5mm)

Tolerances

(Unless Otherwise Specified)

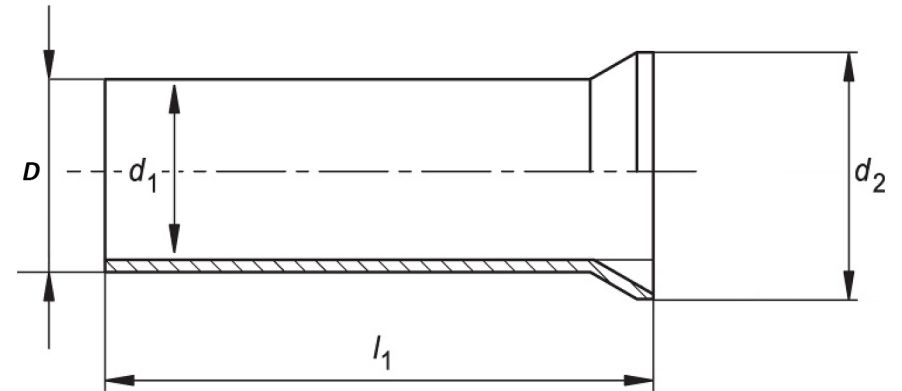

CATEGORY

Non Insulated
Wire Ferrule

SCALE

4/1

PART #

SF1120025

SHEET

1-1

MATERIAL

Tin-Plated Copper

PAGE



FerrulesDirect

