

## Notes:

1. Maximum Electric Current: 35A
2. Maximum Electric Rating: Up to 2000V
3. Terminal Material: Copper
4. Wire Range: 12 AWG (4.00mm<sup>2</sup>)

### Standard (Metric)

L1: 0.98 (25.0mm)  
D: 0.13 (3.2mm)  
D1: 0.11 (2.8mm)  
D2: 0.15 (3.9mm)

### Tolerances

(Unless Otherwise Specified)

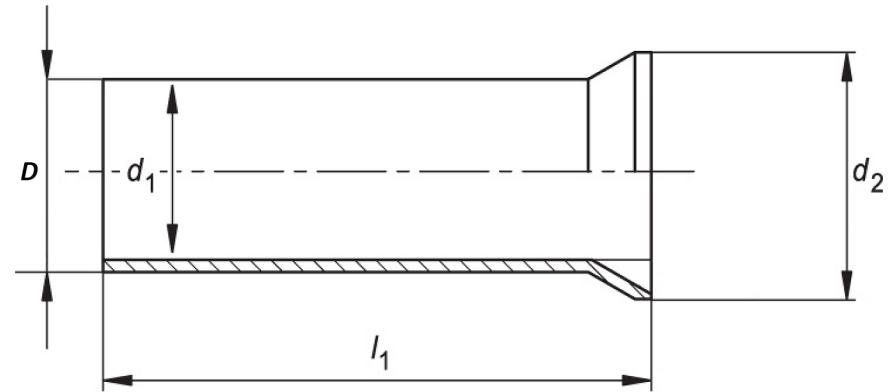

CATEGORY

Non Insulated  
Wire Ferrule

SCALE

4/1

PART #

N40025

SHEET

1-1

MATERIAL

Tin-Plated Copper

PAGE



FerrulesDirect

