

Notes:

1. Maximum Electric Current: 35A
2. Maximum Electric Rating: Up to 2000V
3. Terminal Material: Copper
4. Wire Range: 12 AWG (4.00mm²)

Standard (Metric)

L1: 0.59 (15.0mm)
D: 0.13 (3.2mm)
D1: 0.11 (2.8mm)
D2: 0.15 (3.9mm)

Tolerances

(Unless Otherwise Specified)

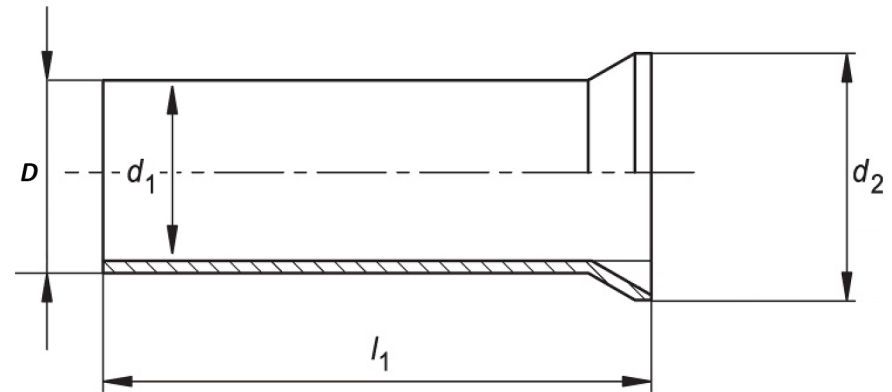

CATEGORY

Non Insulated
Wire Ferrule

SCALE

4/1

PART #

N40015

SHEET

1-1

MATERIAL

Tin-Plated Copper

PAGE



FerrulesDirect

