

Notes:

1. Maximum Electric Current: 170A
2. Maximum Electric Rating: Up to 2000V
3. Terminal Material: Copper
4. Wire Range: 2 AWG (35.00mm²)

Standard (Metric)

L1: 0.59 (15.0mm)
D: 0.34 (8.7mm)
D1: 0.33 (8.3mm)
D2: 0.40 (10.2mm)

Tolerances

(Unless Otherwise Specified)

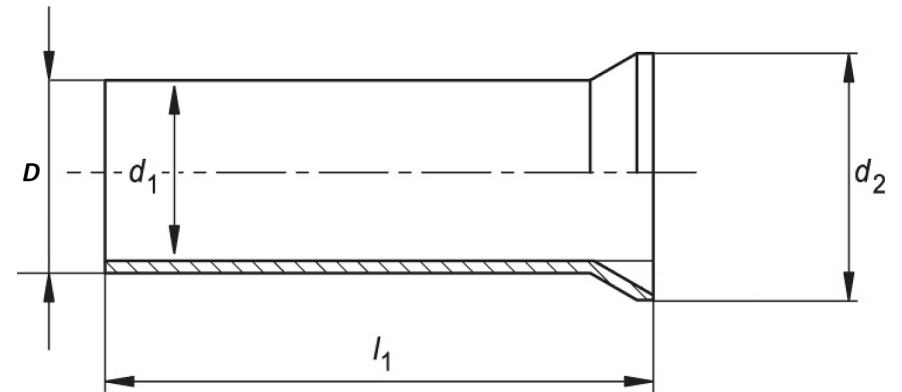

CATEGORY

Non Insulated
Wire Ferrule

SCALE

4/1

PART #

N350015

SHEET

1-1

MATERIAL

Tin-Plated Copper

PAGE



FerrulesDirect

