

Notes:

1. Maximum Electric Current: 30A
2. Maximum Electric Rating: Up to 2000V
3. Terminal Material: Copper
4. Wire Range: 14 AWG (2.50mm²)

Standard (Metric)

L1: 0.28 (7.0mm)
D: 0.10 (2.6mm)
D1: 0.08 (2.1mm)
D2: 0.13 (3.3mm)

Tolerances

(Unless Otherwise Specified)

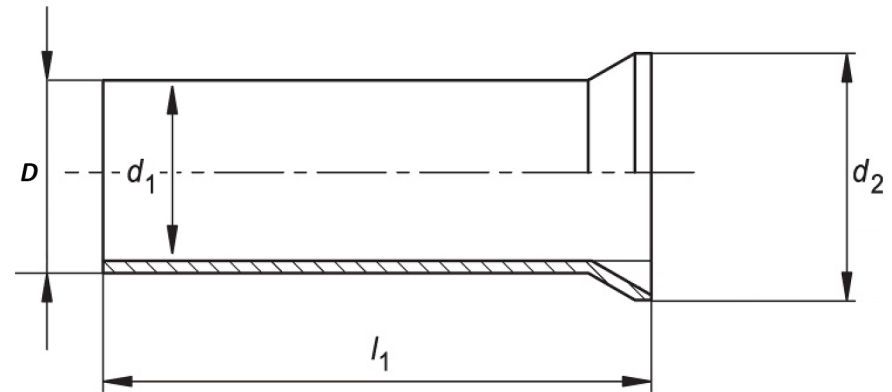

CATEGORY

Non Insulated
Wire Ferrule

SCALE

4/1

PART #

N25007

SHEET

1-1

MATERIAL

Tin-Plated Copper

PAGE



FerrulesDirect

