

Notes:

1. Maximum Electric Current: 18A
2. Maximum Electric Rating: Up to 2000V
3. Terminal Material: Copper
4. Wire Range: 16 AWG (1.50mm²)

Standard (Metric)

L1: 0.24 (6.0mm)
D: 0.08 (2.0mm)
D1: 0.07 (1.7mm)
D2: 0.10 (2.5mm)

Tolerances

(Unless Otherwise Specified)

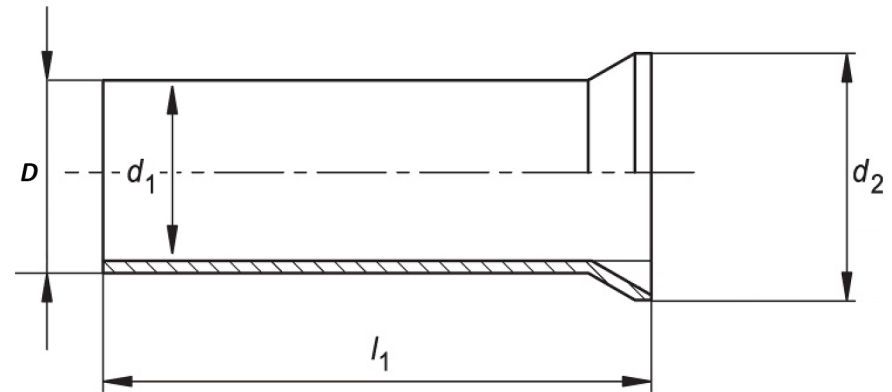

CATEGORY

Non Insulated
Wire Ferrule

SCALE

4/1

PART #

N15006

SHEET

1-1

MATERIAL

Tin-Plated Copper

PAGE



FerrulesDirect

