

Notes:

1. Cross Section: 300MCM
2. Maximum Electric Current: 445AMP
3. Maximum Electric Rating: 105°C
4. Voltage Rating: 2000V
5. Terminal Material: Copper
6. Terminal Surface Treatment: Tin Plating

Standard (Metric)

L1: 40.0mm (1.57")
D: 20.6mm (0.41")
D1: 19.6mm (0.77")
D2: 23.0mm (0.91")

Tolerances

(Unless Otherwise Specified)

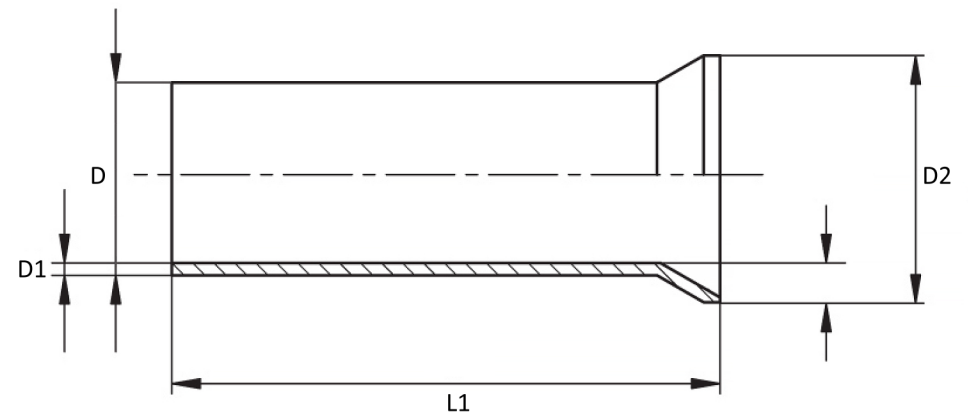

CATEGORY

Non Insulated Wire Ferrules

SCALE

1-1

PART

N1500040

MATERIAL

Tin-Plated Copper

PAGE

10F2



FerrulesDirect

For applicable tools, visit our website: www.FerrulesDirect.com