

## Notes:

1. Cross Section: 4/0 AWG (120mm<sup>2</sup>)
2. Maximum Electric Current: 360AMP
3. Maximum Electric Rating: 105°C
4. Voltage Rating: 2000V
5. Terminal Material: Copper
6. Terminal Surface Treatment: Tin Plating

### Standard (Metric)

L1: 38.0mm (1.50")  
D: 17.7mm (0.69")  
D1: 16.7mm (0.65")  
D2: 19.0mm (0.75")

### Tolerances

(Unless Otherwise Specified)

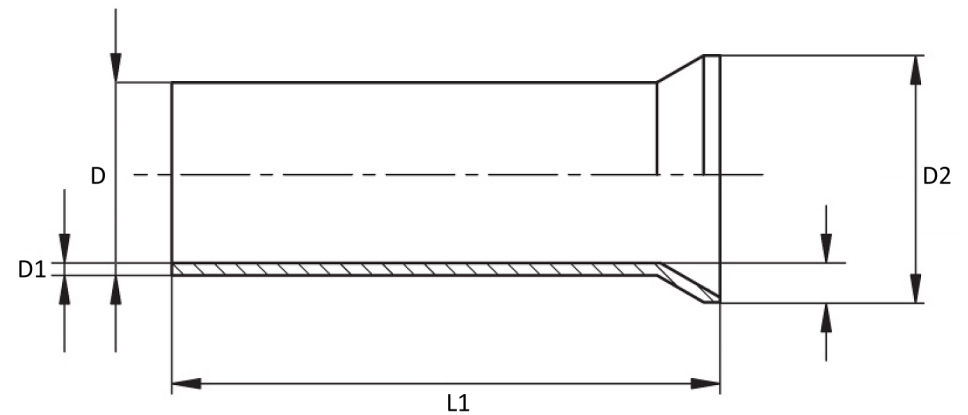

#### CATEGORY

Non Insulated Wire Ferrules

#### SCALE

1-1

#### PART #

N1200038

#### MATERIAL

Tin-Plated Copper

#### PAGE

10F2



**FerrulesDirect**

For applicable tools, visit our website: [www.FerrulesDirect.com](http://www.FerrulesDirect.com)