

Notes:

1. Maximum Electric Current: 70A
2. Maximum Electric Rating: Up to 2000V
3. Terminal Material: Copper
4. Wire Range: 8 AWG (6.00mm²)

Standard (Metric)

L1: 22mm² (0.86")
D: 4.6mm² (0.18")
D1: 4.2mm² (0.16")
D2: 5.8mm² (0.23")

Tolerances

(Unless Otherwise Specified)

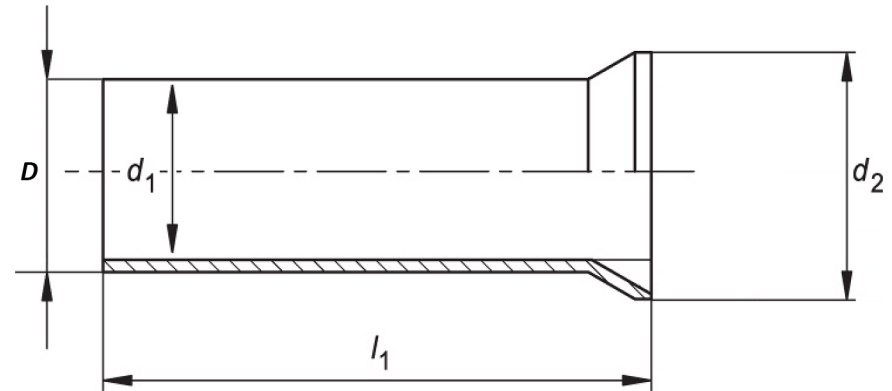

CATEGORY

Non Insulated
Wire Ferrule

SCALE

4/1

PART #

N100022

SHEET

1-1

MATERIAL

Tin-Plated Copper

PAGE



FerrulesDirect

