

## Notes:

1. Maximum Electric Current: 17A
2. Maximum Electric Rating: Up to 2000V
3. Terminal Material: Copper
4. Wire Range: 20 AWG (0.75mm<sup>2</sup>)

### Standard (Metric)

L1: 0.24 (6.0mm)  
D: 0.06 (1.5mm)  
D1: 0.05 (1.2mm)  
D2: 0.09 (2.3mm)

### Tolerances

(Unless Otherwise Specified)

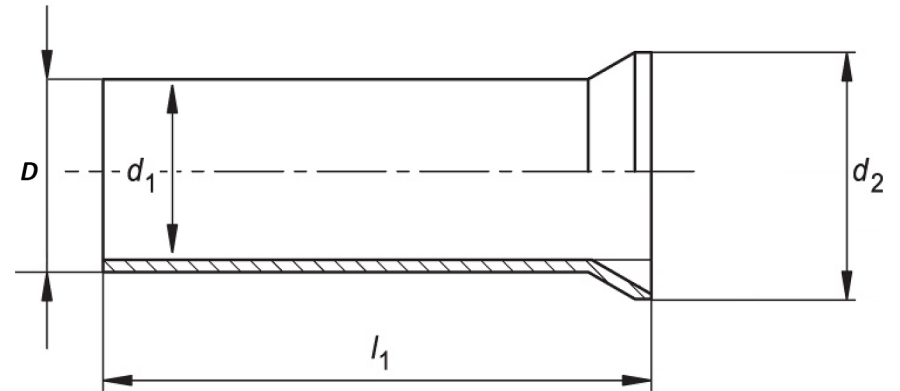

CATEGORY

Non Insulated  
Wire Ferrule

SCALE

4/1

PART #

N07506

SHEET

1-1

MATERIAL

Tin-Plated Copper

PAGE



FerrulesDirect

