

Notes:

1. Maximum Electric Current: 12A
2. Maximum Electric Rating: Up to 2000V
3. Terminal Material: Copper
4. Wire Range: 22 AWG (0.50mm²)

Standard (Metric)

L1: 0.47 (12.0mm)
D: 0.05 (1.3mm)
D1: 0.04 (1.0mm)
D2: 0.08 (2.1mm)

Tolerances

(Unless Otherwise Specified)

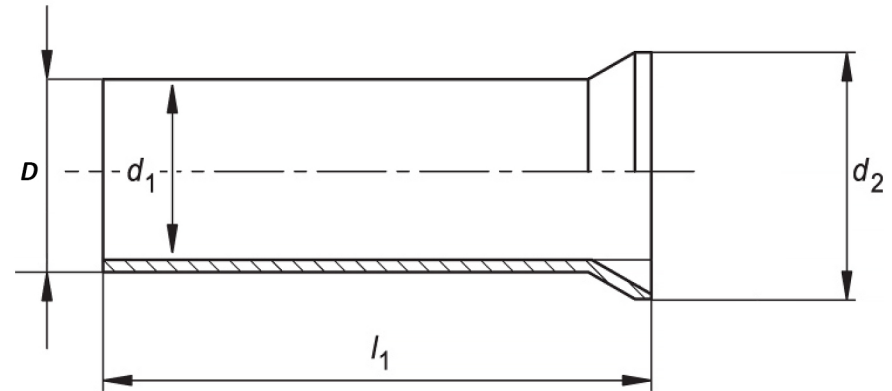

CATEGORY

Non Insulated
Wire Ferrule

SCALE

4/1

PART #

N05012

SHEET

1-1

MATERIAL

Tin-Plated Copper

PAGE



FerrulesDirect

