

Notes:

1. Maximum Electric Current: 7A
2. Maximum Electric Rating: Up to 2000V
3. Terminal Material: Copper
4. Wire Range: 24 AWG (0.25mm²)

Standard (Metric)

L1: 0.28 (7.0mm)
D: 0.04 (1.1mm)
D1: 0.03 (0.8mm)
D2: 0.59 (1.5mm)

Tolerances

(Unless Otherwise Specified)

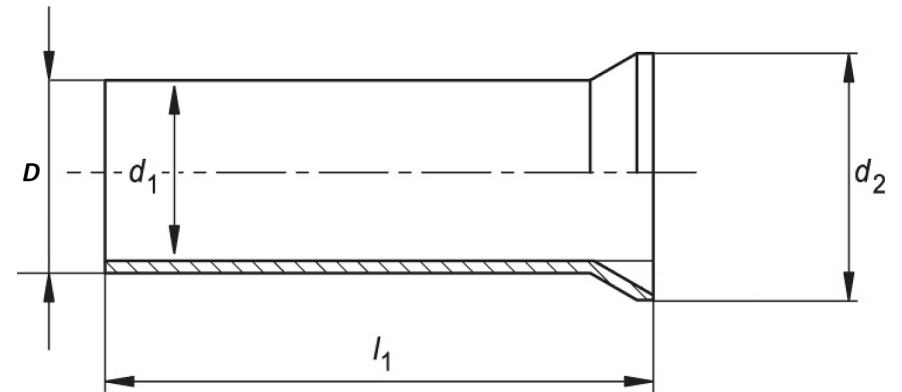

CATEGORY

Non Insulated
Wire Ferrule

SCALE

4/1

PART #

N02507

SHEET

1-1

MATERIAL

Tin-Plated Copper

PAGE



FerrulesDirect

