

Notes:

1. Maximum Electric Current: 35A
2. Maximum Electric Rating: 105°C 600 Volts Max
3. Insulation Material: Nylon
4. Insulation Color: Gray
5. Terminal Material: Copper
6. Wire Range: 12 AWG (4.00mm²)

Standard (Metric)

L1: 0.77 (19.6mm)
L2: 0.47 (12.0mm)
D: 0.13 (3.3mm)
D1: 0.11 (2.8mm)
D2: 0.19 (4.8mm)

Tolerances

(Unless Otherwise Specified)

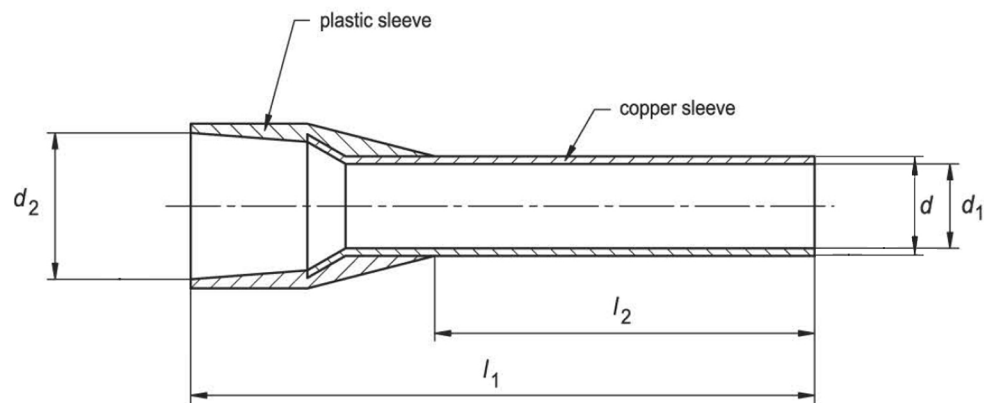

CATEGORY	Insulated Wire Ferrule	SCALE	4/1
PART #	AW40012	SHEET	1-1
MATERIAL	Tin-Plated Copper	PAGE	

