

Notes:

1. Maximum Electric Current: 30A
2. Maximum Electric Rating: 105°C 600 Volts Max
3. Insulation Material: Nylon
4. Insulation Color: Yellow
5. Terminal Material: Copper
6. Wire Range: True 14 AWG (2.08mm²)

Standard (Metric)

L1: 0.94 (24.0mm)
L2: 0.71 (18.0mm)
D: 0.09 (2.4mm)
D1: 0.08 (2.05mm)
D2: 0.13 (3.4mm)

Tolerances

(Unless Otherwise Specified)

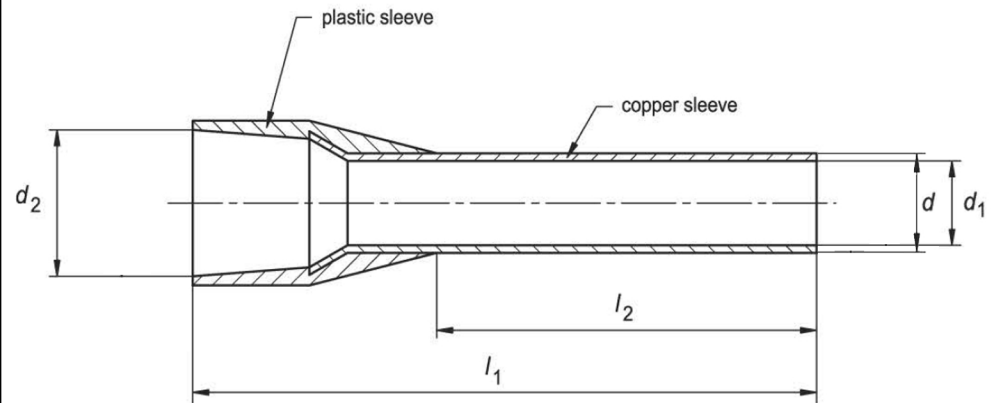

CATEGORY	Insulated Wire Ferrule	SCALE	4/1
PART #	AW20018	SHEET	1-1
MATERIAL	Tin-Plated Copper	PAGE	