

Notes:

1. Maximum Electric Current: 12A
2. Maximum Electric Rating: 105°C 600 Volts Max
3. Insulation Material: Nylon
4. Insulation Color: Orange
5. Terminal Material: Copper
6. Wire Range: 22 AWG (0.50mm²)

Standard (Metric)

L1: 0.63 (16mm)
L2: 0.39 (10.0mm)
D: 0.051 (1.3mm)
D1: 0.04 (1.0mm)
D2: 0.102 (2.6mm)

Tolerances

(Unless Otherwise Specified)

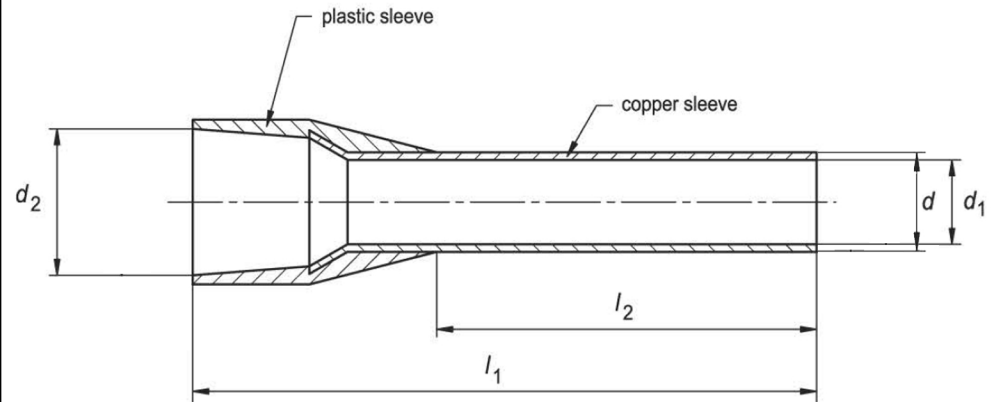

CATEGORY	Insulated Wire Ferrule	SCALE	4/1
PART #	AW05010	SHEET	1-1
MATERIAL	Tin-Plated Copper	PAGE	



FerrulesDirect

