

## Notes:

1. Maximum Electric Current: 35A
2. Maximum Electric Rating: 105°C 600 Volts Max
3. Insulation Material: Nylon
4. Insulation Color: Orange
5. Terminal Material: Copper
6. Wire Range: 12 AWG (4.00mm<sup>2</sup>)

### Standard (Metric)

L1: 0.77 (19.6mm)  
 L2: 0.47 (12.0mm)  
 D: 0.13 (3.3mm)  
 D1: 0.11 (2.8mm)  
 D2: 0.19 (4.8mm)

### Tolerances

(Unless Otherwise Specified)

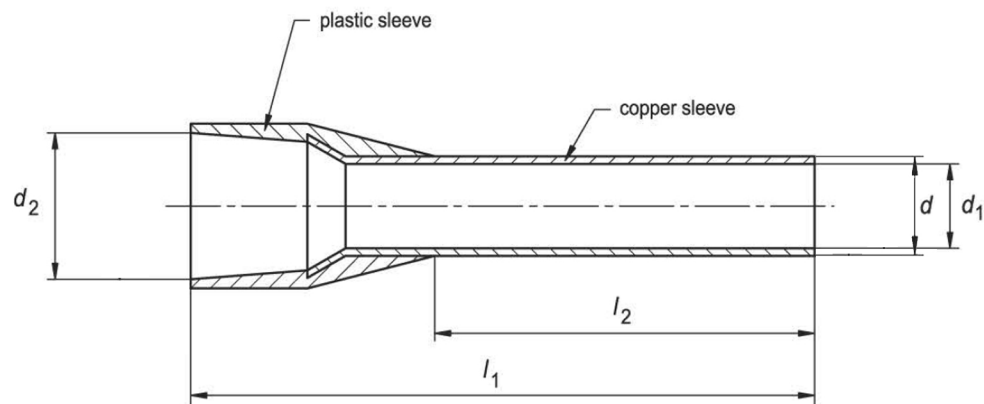

<b>CATEGORY</b>	Insulated Wire Ferrule	<b>SCALE</b>	4/1
<b>PART #</b>	AT40012	<b>SHEET</b>	1-1
<b>MATERIAL</b>	Tin-Plated Copper	<b>PAGE</b>	

