

## Notes:

1. Maximum Electric Current: 17A
2. Maximum Electric Rating: 105°C 600 Volts Max
3. Insulation Material: Nylon
4. Insulation Color: Blue
5. Terminal Material: Copper
6. Wire Range: 20 AWG (0.75mm<sup>2</sup>)

## Standard (Metric)

L1: 0.55 (14.0mm)  
L2: 0.32 (8.0mm)  
D: 0.062 (1.57mm)  
D1: 0.05 (1.2mm)  
D2: 0.110 (2.8mm)

## Tolerances

(Unless Otherwise Specified)

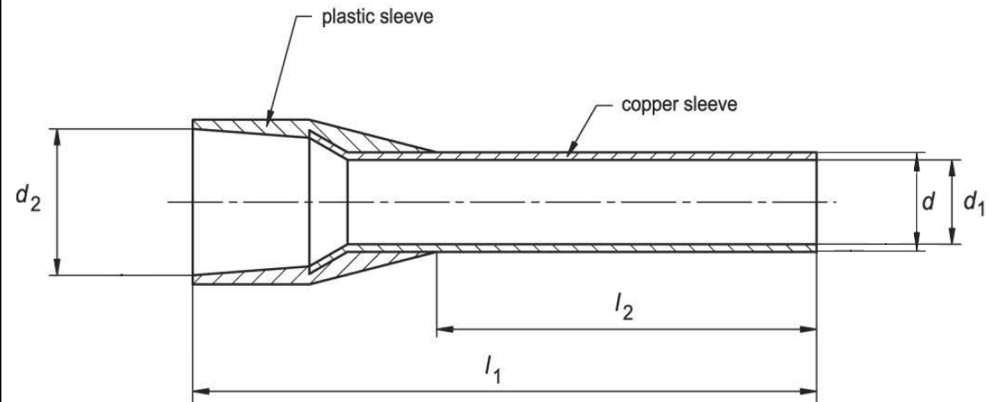

<b>CATEGORY</b>	Insulated Wire Ferrule	<b>SCALE</b>	4/1
<b>PART #</b>	AT07508	<b>SHEET</b>	1-1
<b>MATERIAL</b>	Tin-Plated Copper	<b>PAGE</b>	



**FerrulesDirect**

