

Notes:

1. Maximum Electric Current: 7A
2. Maximum Electric Rating: 105°C 600 Volts Max
3. Insulation Material: Nylon
4. Insulation Color: Yellow
5. Terminal Material: Copper
6. Wire Range: 24 AWG (0.25mm²)

Standard (Metric)

L1: 0.49 (12.4mm)
L2: 0.32 (8.0mm)
D: 0.043 (1.10mm)
D1: 0.031 (0.8mm)
D2: 0.062 (1.6mm)

Tolerances

(Unless Otherwise Specified)

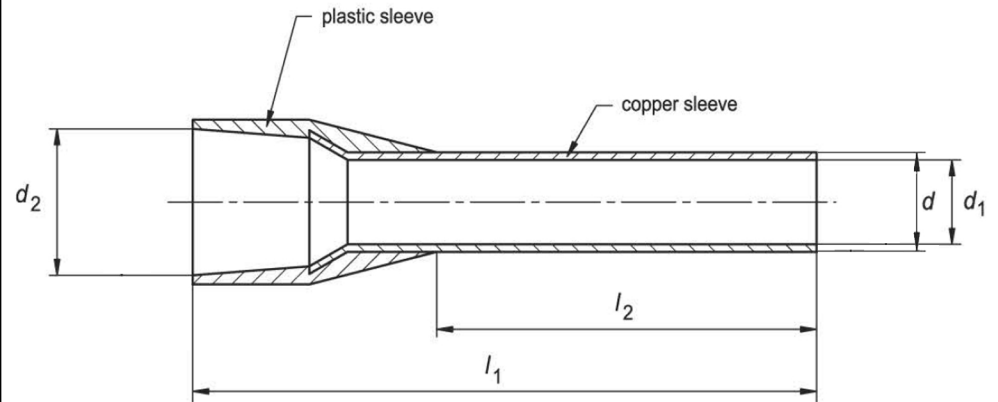

CATEGORY	Insulated Wire Ferrule	SCALE	4/1
PART #	AT02508	SHEET	1-1
MATERIAL	Tin-Plated Copper	PAGE	



FerrulesDirect

