

Notes:

1. Maximum Electric Current: 230A
2. Maximum Electric Rating: 105°C 600 Volts Max
3. Insulation Material: Nylon
4. Insulation Color: Blue
5. Terminal Material: Copper
6. Wire Range: True 0 & 1/0 AWG (53.5mm²)

Standard (Metric)

L1: 1.81 (46.0mm)
L2: 1.18 (30.0mm)
D: 0.48 (12.2mm)
D1: 0.46 (11.6mm)
D2: 0.64 (16.3mm)

Tolerances

(Unless Otherwise Specified)

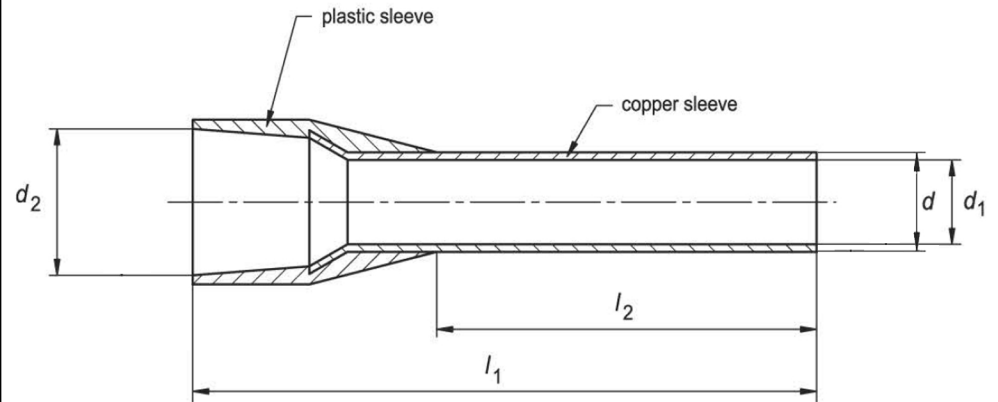

CATEGORY	Insulated Wire Ferrule	SCALE	4/1
PART #	AD560030	SHEET	1-1
MATERIAL	Tin-Plated Copper	PAGE	