

Notes:

1. Maximum Electric Current: 18A
2. Maximum Electric Rating: 105°C 600 Volts Max
3. Insulation Material: Nylon
4. Insulation Color: Red
5. Terminal Material: Copper
6. Wire Range: 18 AWG (1.00mm²)

Standard (Metric)

L1: 0.47 (12.0mm)
L2: 0.24 (6.0mm)
D: 0.067 (1.7mm)
D1: 0.055 (1.4mm)
D2: 0.11 (2.8mm)

Tolerances

(Unless Otherwise Specified)

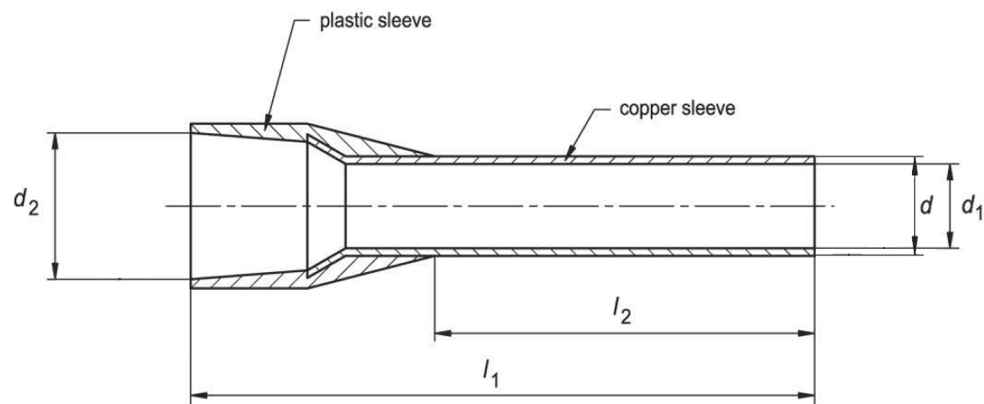

CATEGORY	Insulated Wire Ferrule	SCALE	4/1
PART #	AD10006	SHEET	1-1
MATERIAL	Tin-Plated Copper	PAGE	



FerrulesDirect