

Notes:

1. Maximum Electric Current: 17A
2. Maximum Electric Rating: 105°C 600 Volts Max
3. Insulation Material: Nylon
4. Insulation Color: Gray
5. Terminal Material: Copper
6. Wire Range: 20 AWG (0.75mm²)

Standard (Metric)

L1: 0.96 (24.3mm)
L2: 0.71 (18.0mm)
D: 0.062 (1.57mm)
D1: 0.05 (1.2mm)
D2: 0.110 (2.8mm)

Tolerances

(Unless Otherwise Specified)

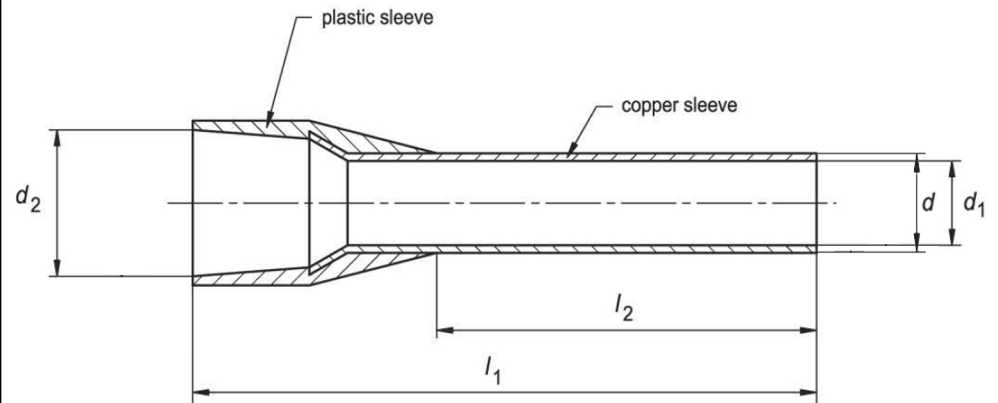

CATEGORY	Insulated Wire Ferrule	SCALE	4/1
PART #	AD07518	SHEET	1-1
MATERIAL	Tin-Plated Copper	PAGE	



FerrulesDirect

