

Notes:

1. Maximum Electric Current: 12A
2. Maximum Electric Rating: 105°C 600 Volts Max
3. Insulation Material: Nylon
4. Insulation Color: White
5. Terminal Material: Copper
6. Wire Range: 22 AWG (0.50mm²)

Standard (Metric)

L1: 0.43 (11mm)
 L2: 0.20 (5.0mm)
 D: 0.051 (1.3mm)
 D1: 0.04 (1.0mm)
 D2: 0.102 (2.6mm)

Tolerances

(Unless Otherwise Specified)

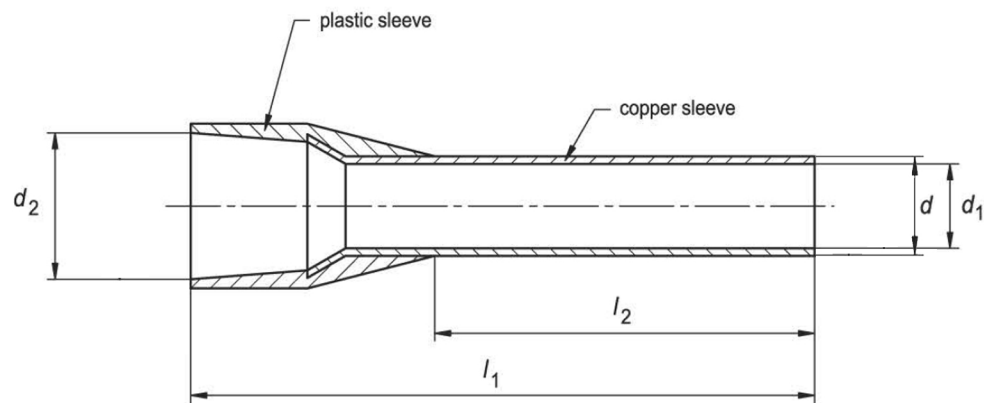

CATEGORY	Insulated Wire Ferrule	SCALE	4/1
PART #	AD05005	SHEET	1-1
MATERIAL	Tin-Plated Copper	PAGE	



FerrulesDirect

